

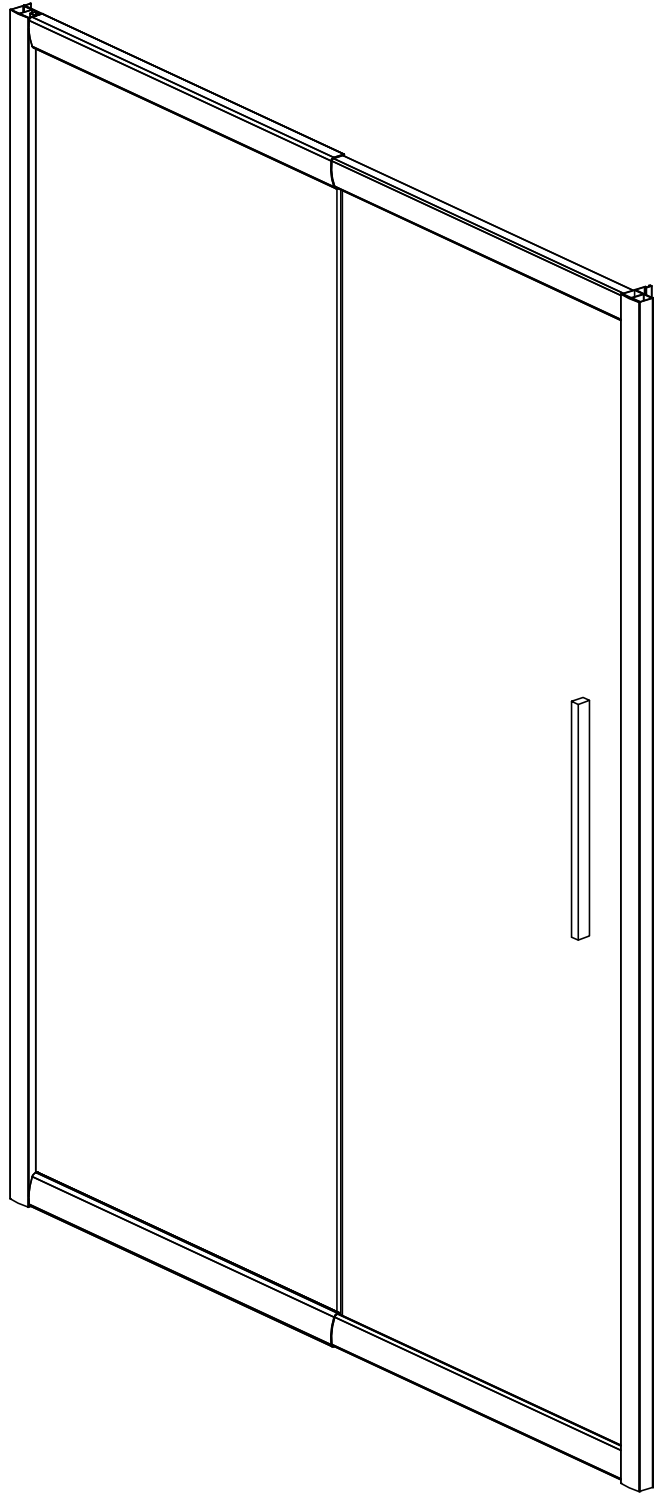

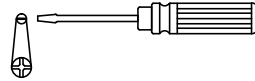

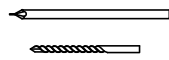

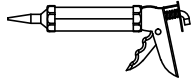

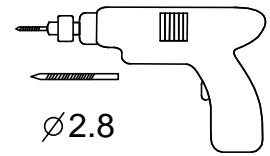
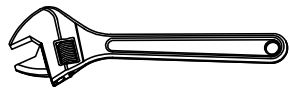
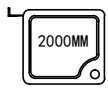

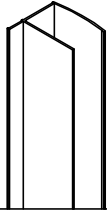
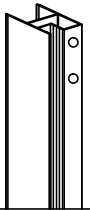
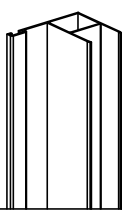
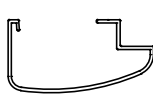

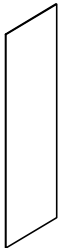
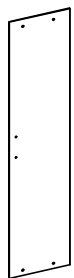
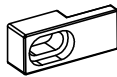
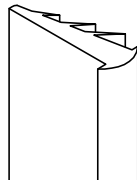
AVACAN^{shower}

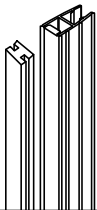
FB/FC-140/160/180

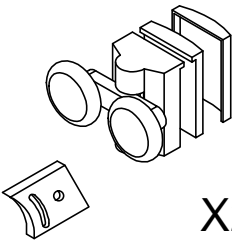
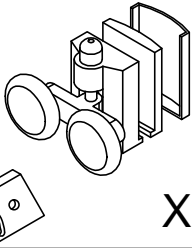
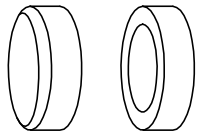
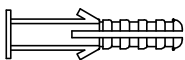



<p>A1</p>  <p>X2</p>	<p>A2</p>  <p>X1</p>	<p>A3</p>  <p>X1</p>	<p>A4</p>  <p>X2</p>	<p>A5</p>  <p>X2</p>
<p>A6</p>  <p>X1</p>	<p>A7</p>  <p>X1</p>	<p>A8</p>  <p>X2</p>	<p>A9</p>  <p>X1</p>	<p>A10</p>  <p>X2</p>
<p>A11</p>  <p>X1</p>	<p>A12</p>  <p>X1</p>	<p>A13</p>  <p>X2</p>	<p>A14</p>  <p>X2</p>	<p>A15</p>  <p>X12</p>
<p>A16</p>  <p>X6</p>	<p>A17</p>  <p>X2</p>	 <p>ST4X12=8 ST4X14=2</p>	 <p>ST4X30=6 ST4X40=8</p>	

ST4X40=8

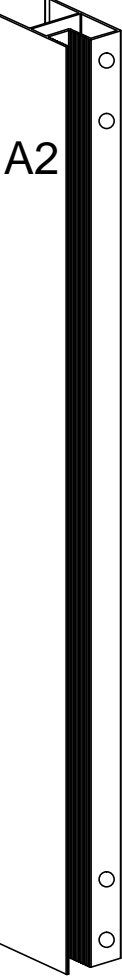
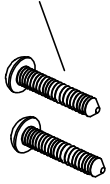

A2

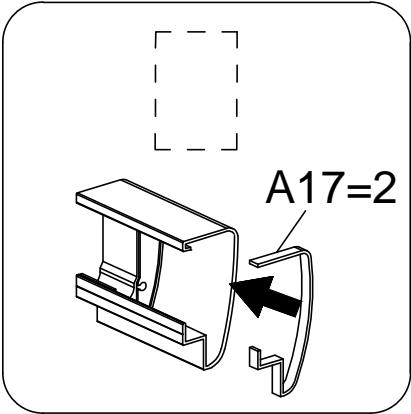
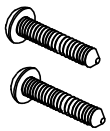

A17=2

A4



1

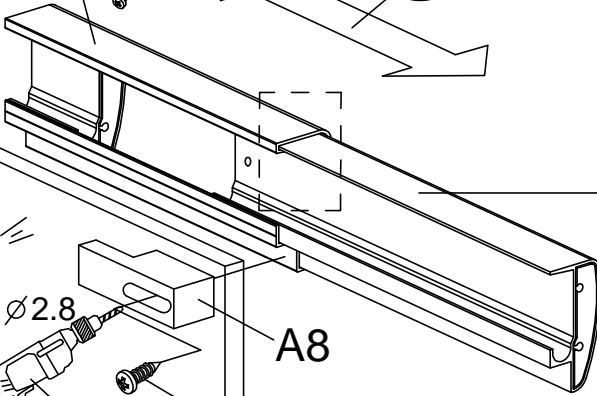
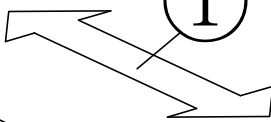

A5



Ø2.8

2

ST4X14=2

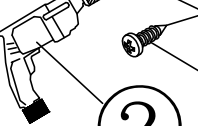

A8

A9



A6

A3

