

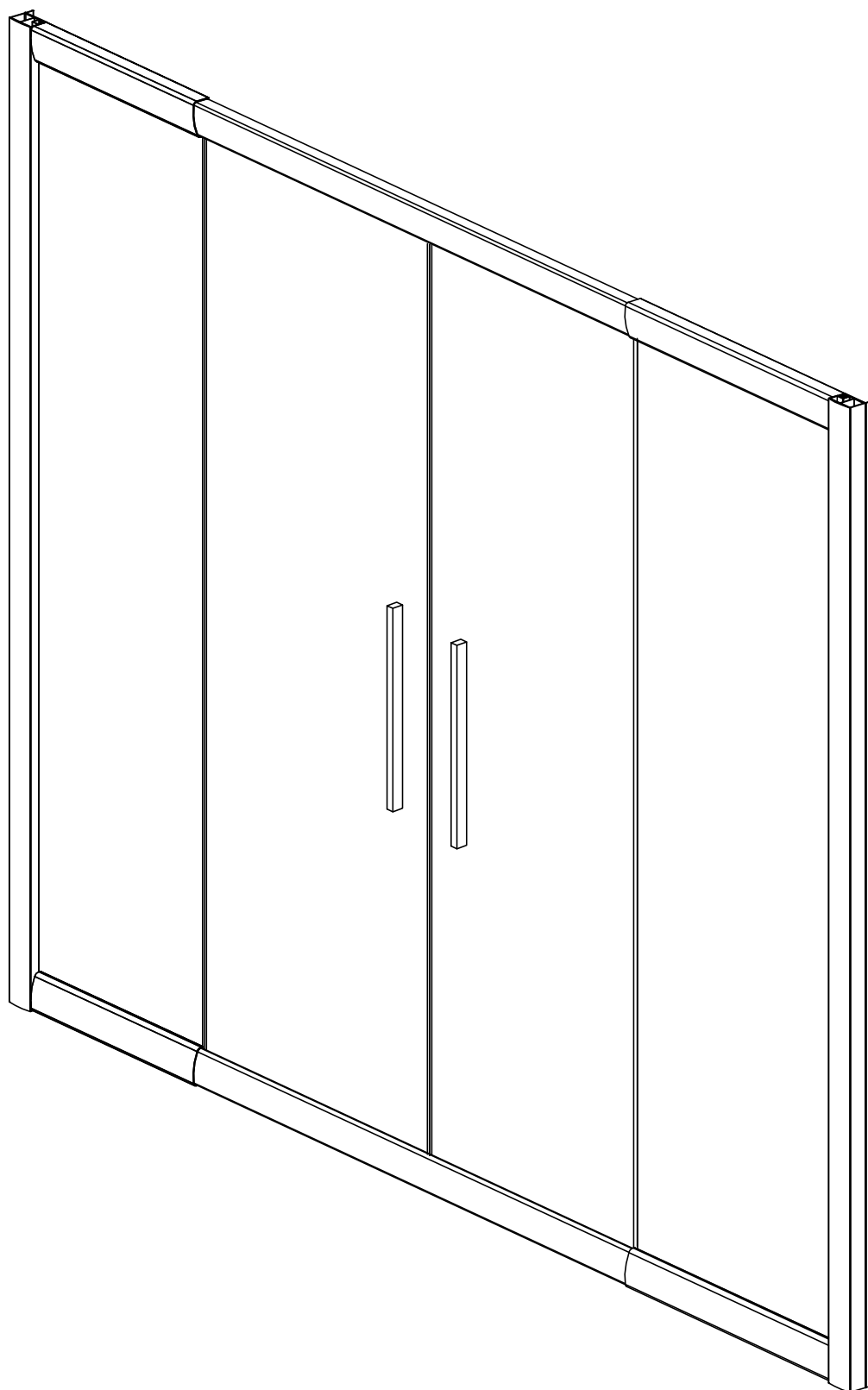

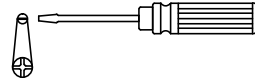

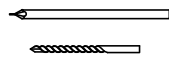
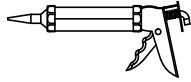
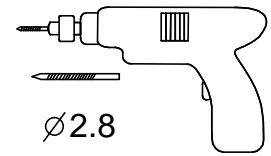
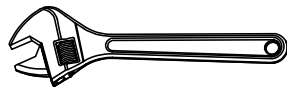
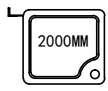
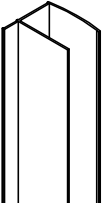
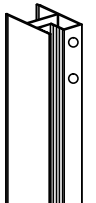

# DETO

## FB2/FC2-170/190



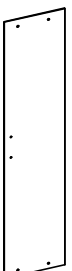
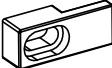
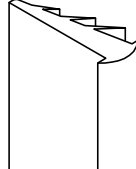
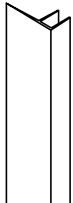
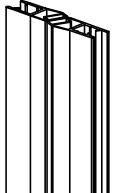
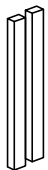
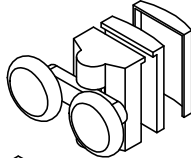
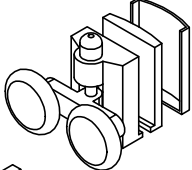
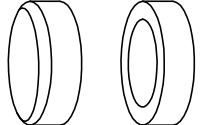
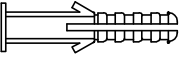

<p>A1</p>  <p>X2</p>	<p>A2</p>  <p>X2</p>	<p>A3</p>  <p>X4</p>	<p>A4</p>  <p>X4</p>	<p>A5</p>  <p>X2</p>
<p>A6</p>  <p>X2</p>	<p>A7</p>  <p>X2</p>	<p>A8</p>  <p>X4</p>	<p>A9</p>  <p>X2</p>	<p>A10</p>  <p>X4</p>
<p>A11</p>  <p>X1</p>	<p>A12</p>  <p>X2</p>	<p>A13</p>  <p>X4</p>	<p>A14</p>  <p>X4</p>	<p>A15</p>  <p>X12</p>
<p>A16</p>  <p>X6</p>	 <p>ST4X12=14 ST4X14=4</p>	 <p>ST4X30=6 ST4X40=8</p>		

ST4X40=8

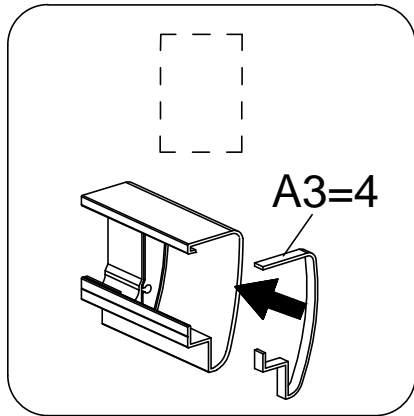
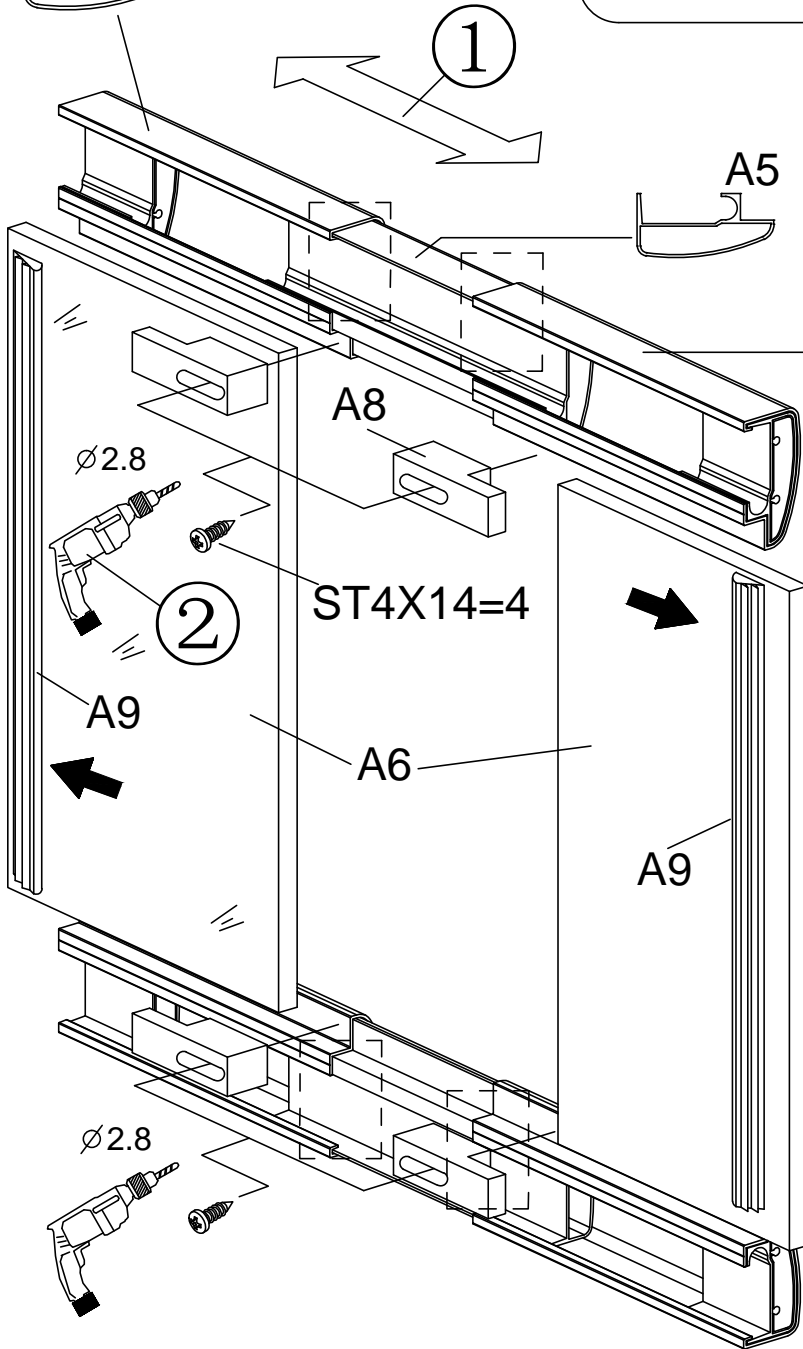
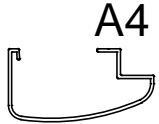
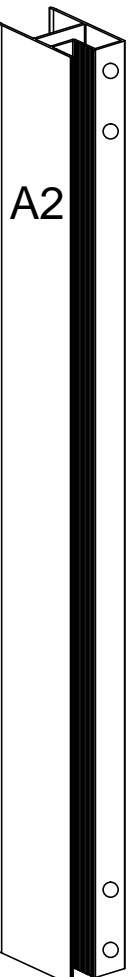
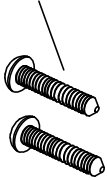

A3=4

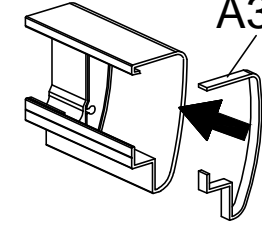

1

A5

A4



A8

$\varnothing 2.8$

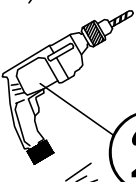

2

ST4X14=4

A9

A6

A9

A2

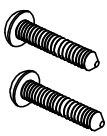
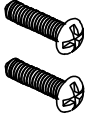

$\varnothing 2.8$

