

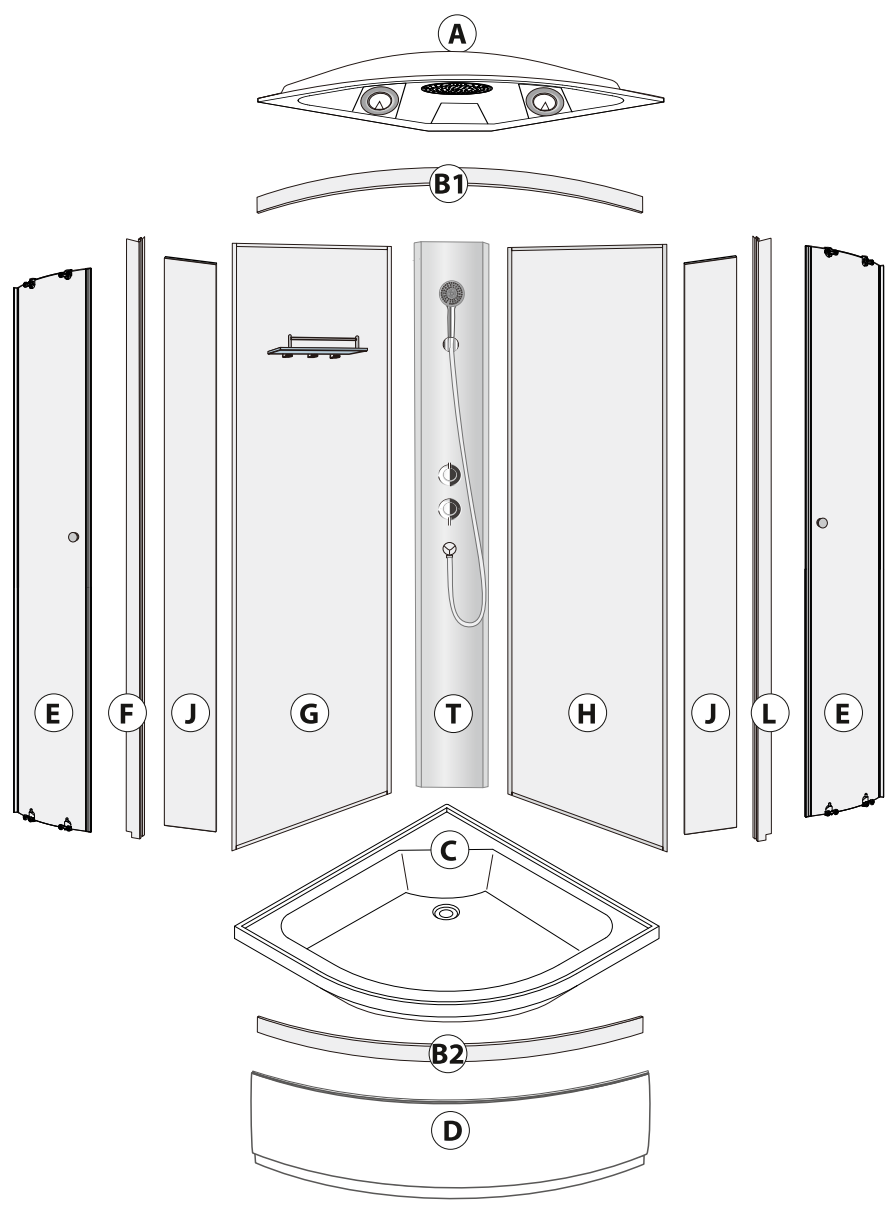

- LM-780 80x80x215cm
- LM-790 90x90x215cm
- LM-710 100x100x215cm

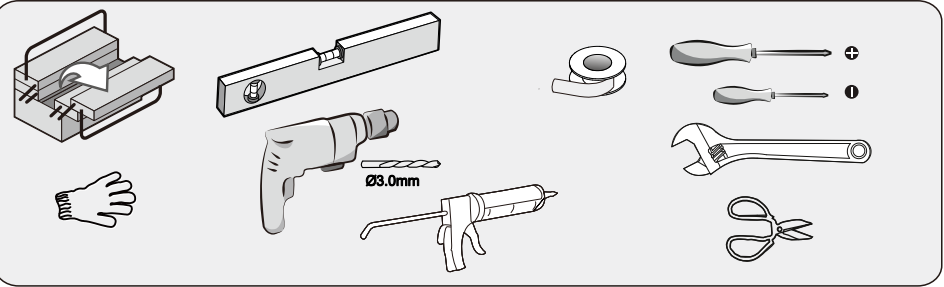

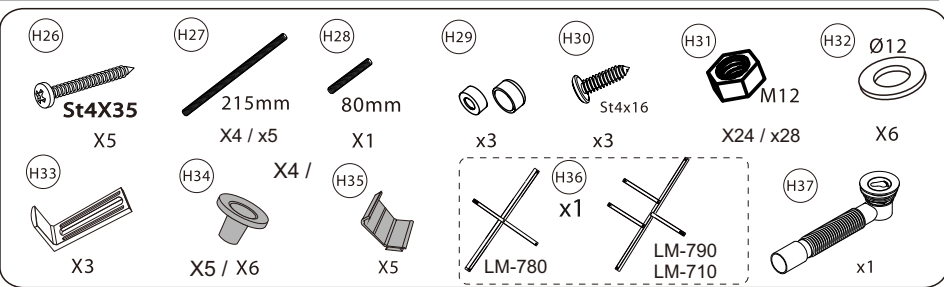
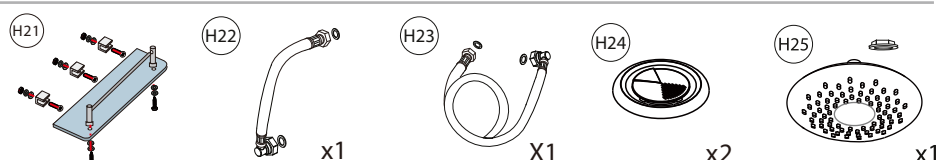
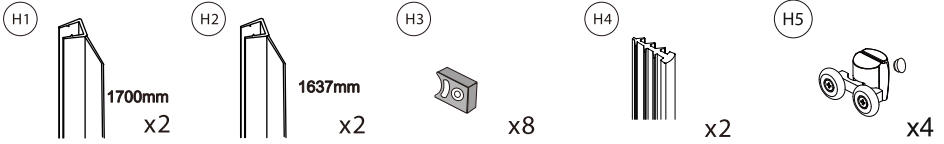
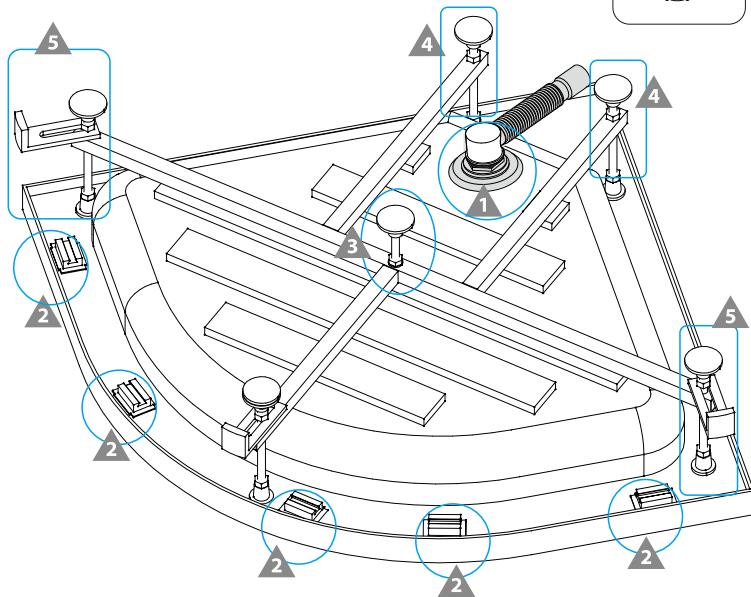
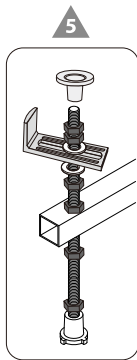
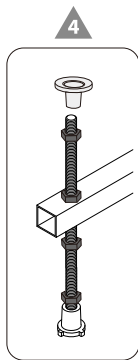
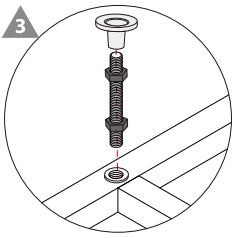
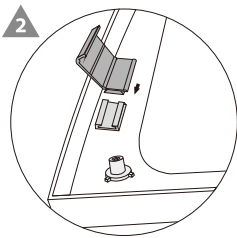
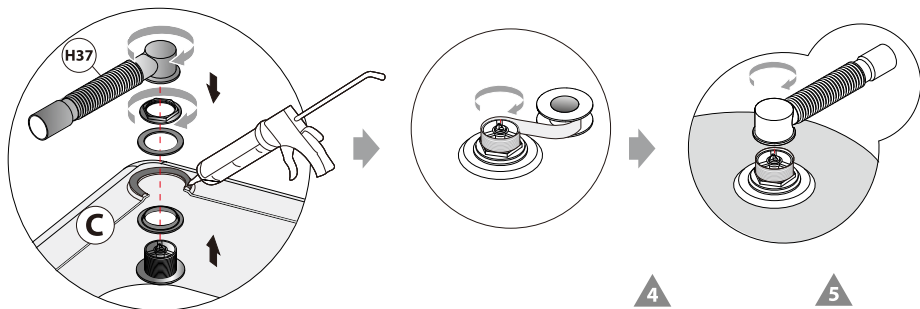

1



-  215mm
 LM-780 X4
 LM-790 X5
 LM-710 X5
-  X1 80mm
-  X6 $\varnothing 12$
-  M12
 LM-780 X24
 LM-790 X28
 LM-710 X28
-  X5
 LM-780 X5
 LM-790 X6
 LM-710 X6

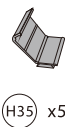
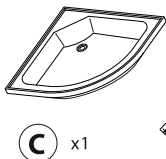
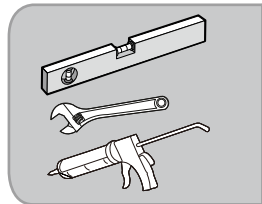

C x1

H36 x1

H37 x1

H35 x5

H33 x3

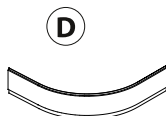
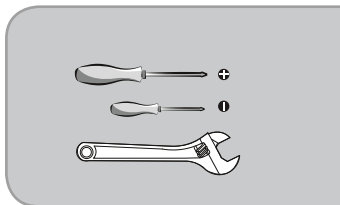
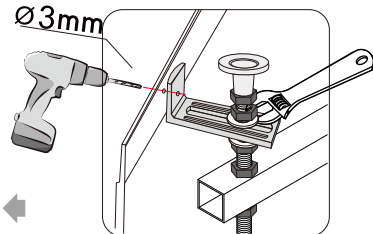
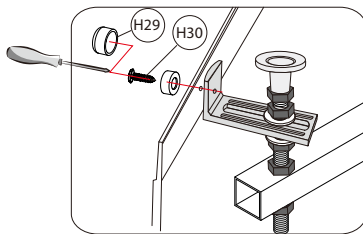
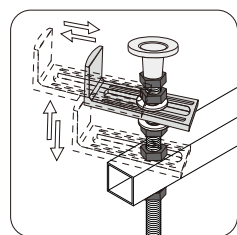
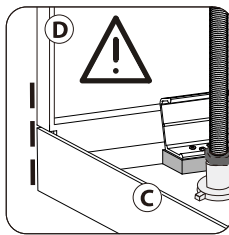
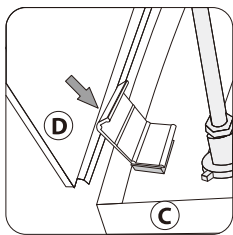
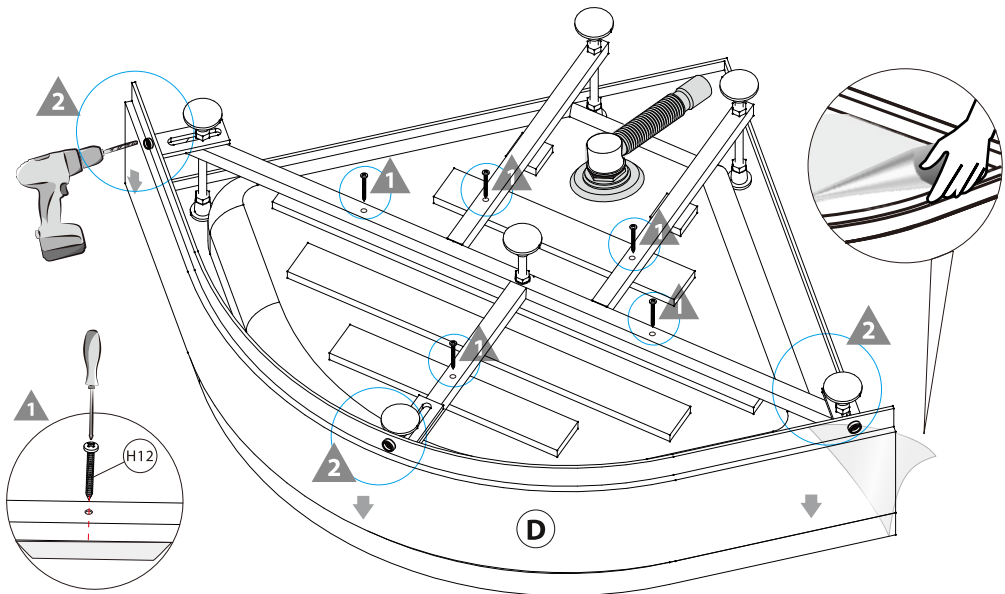

x1

H26



X5

H29



x3

H30



x3

3

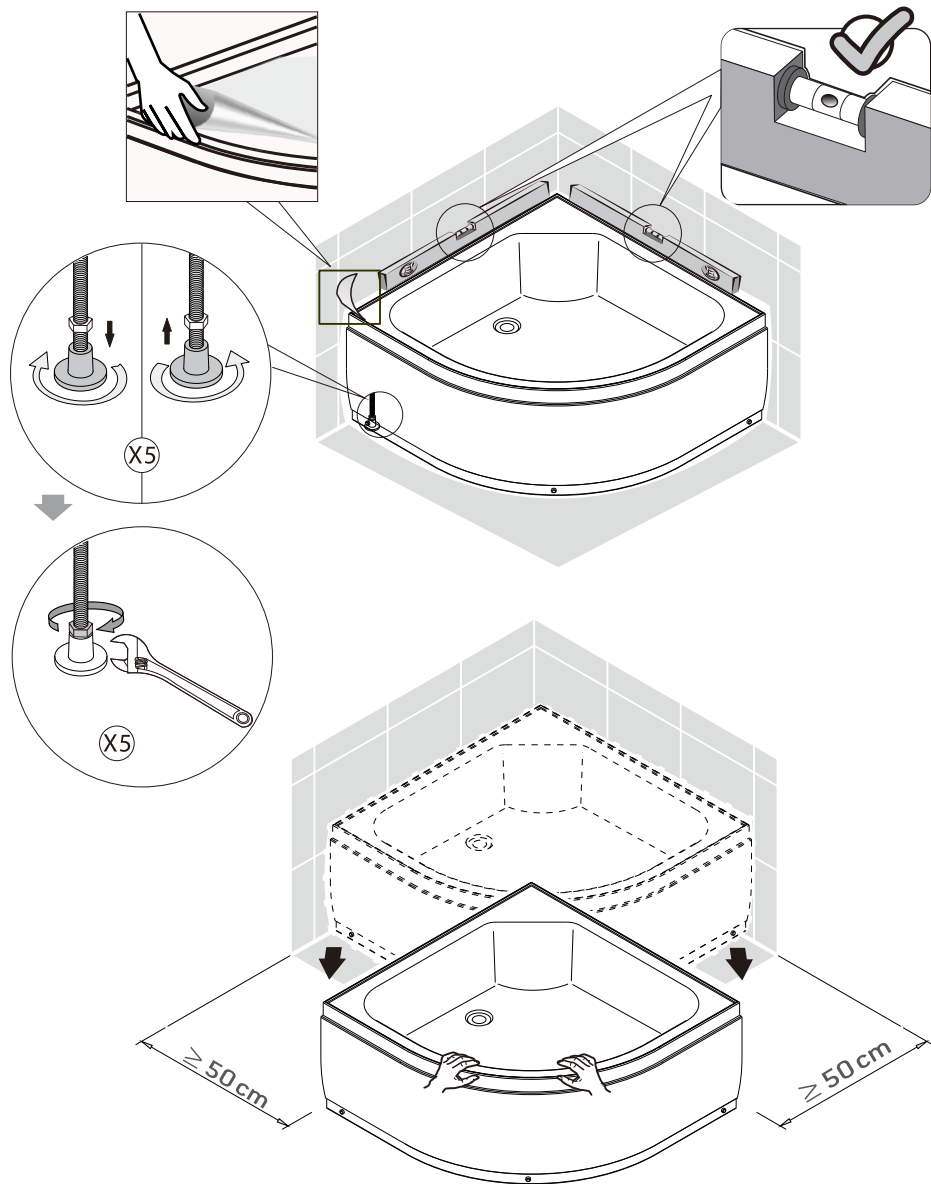

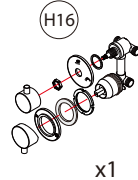
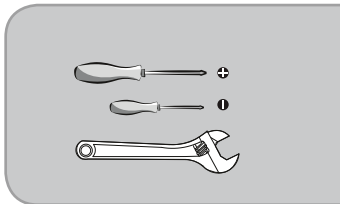
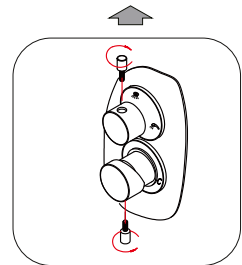
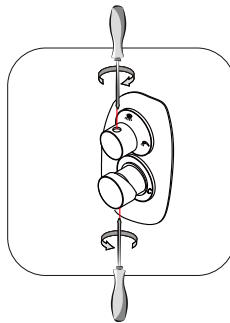
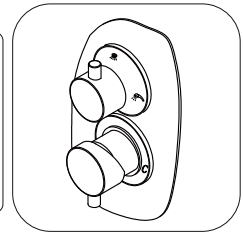
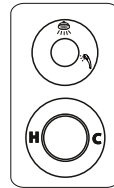
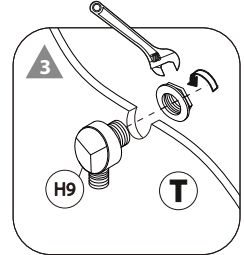
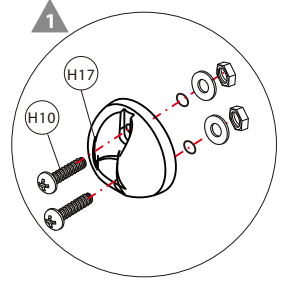
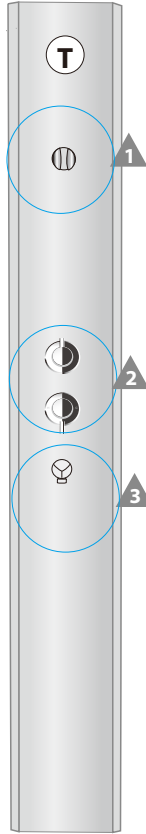
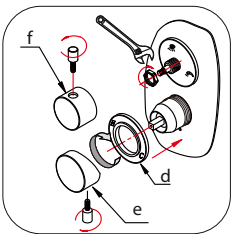
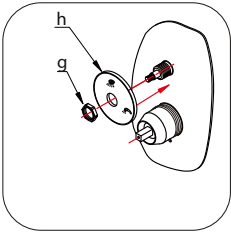
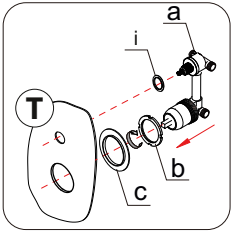
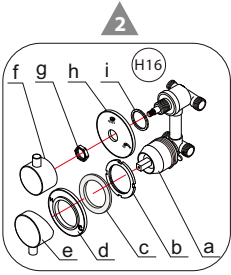

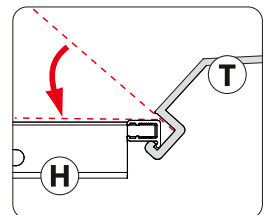
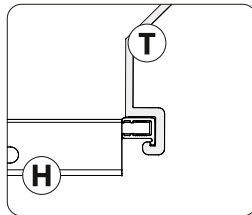
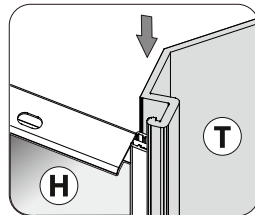
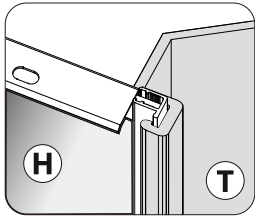
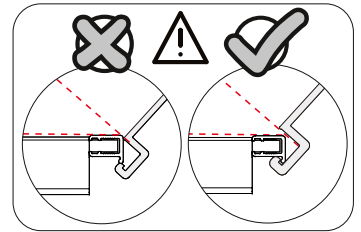
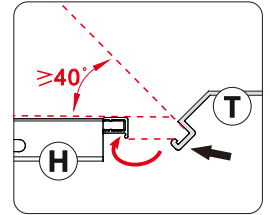
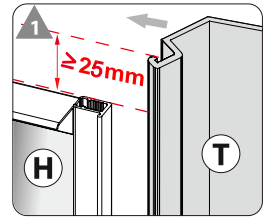
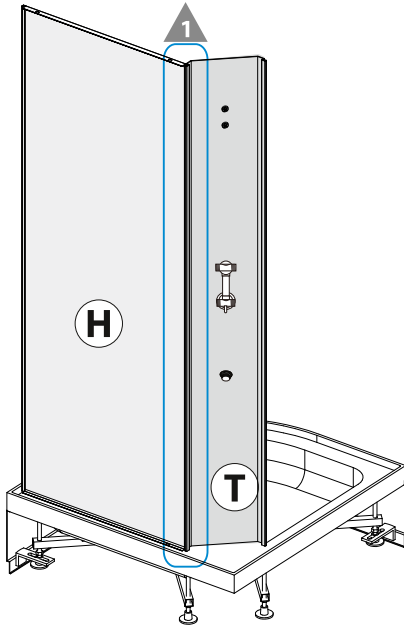

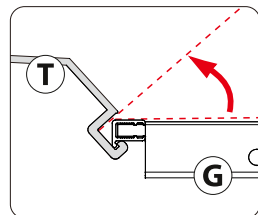
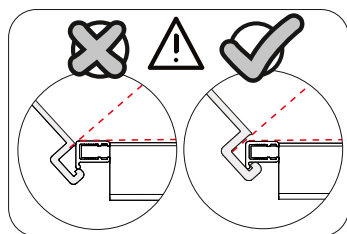
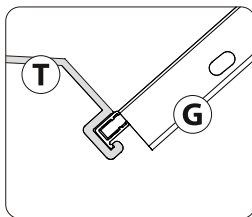
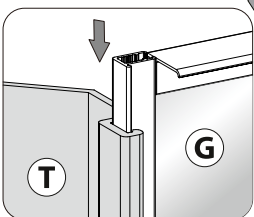
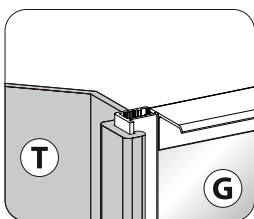
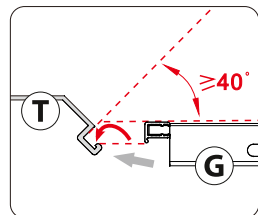
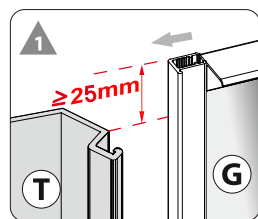
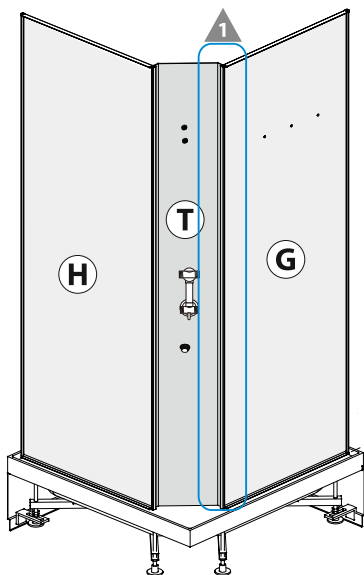

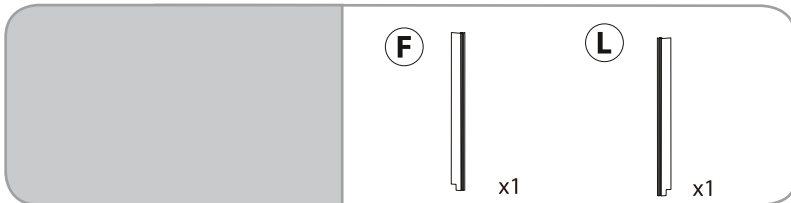
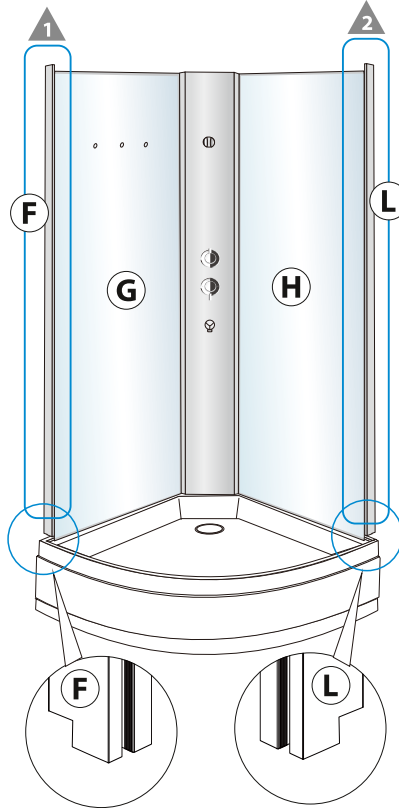
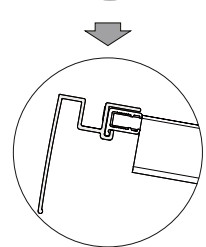
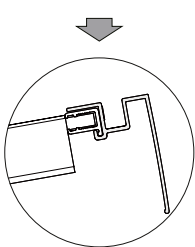
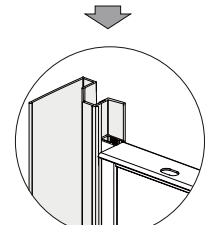
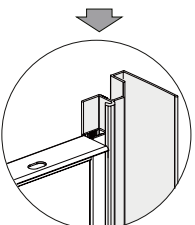
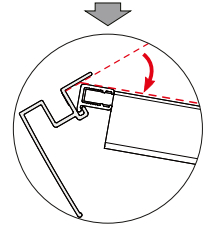
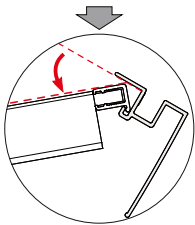
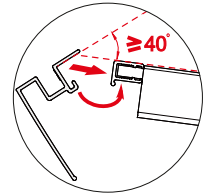
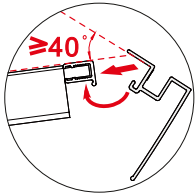
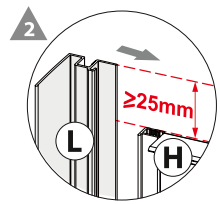
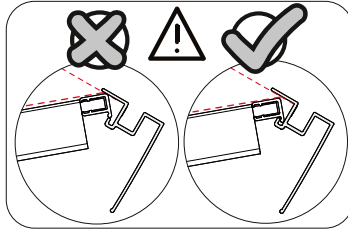
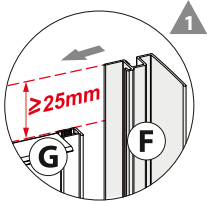

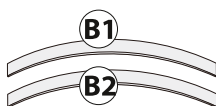
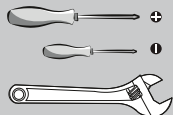
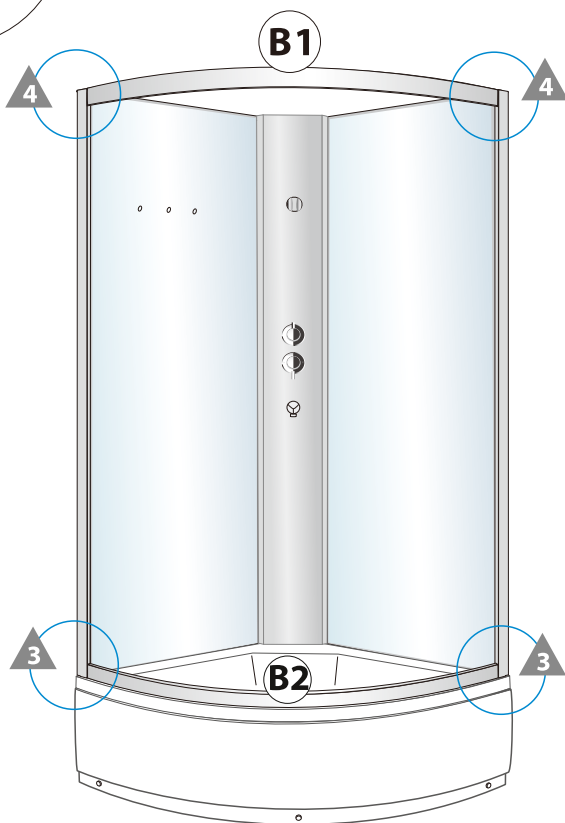
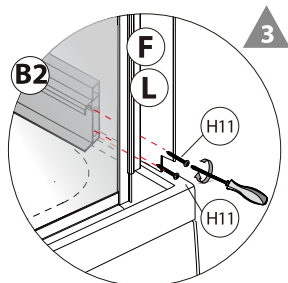
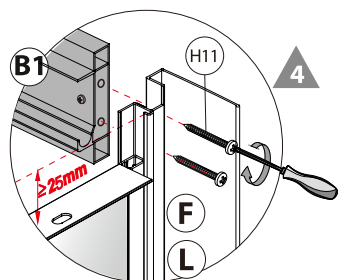
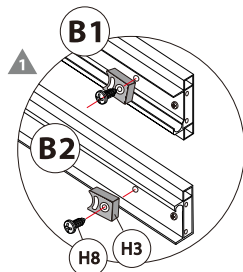
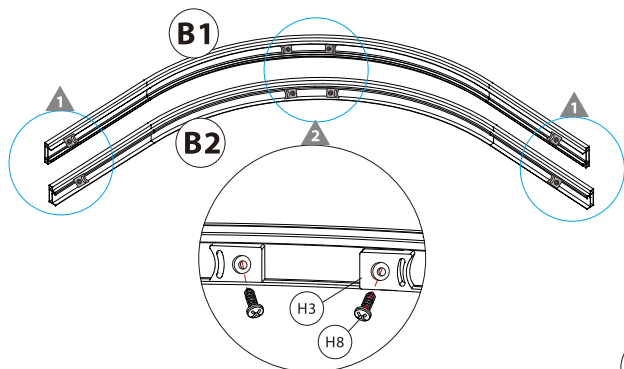

B1

B2

X1

H3



X8

H8



ST4X10

X8

H11



ST4X30

X8

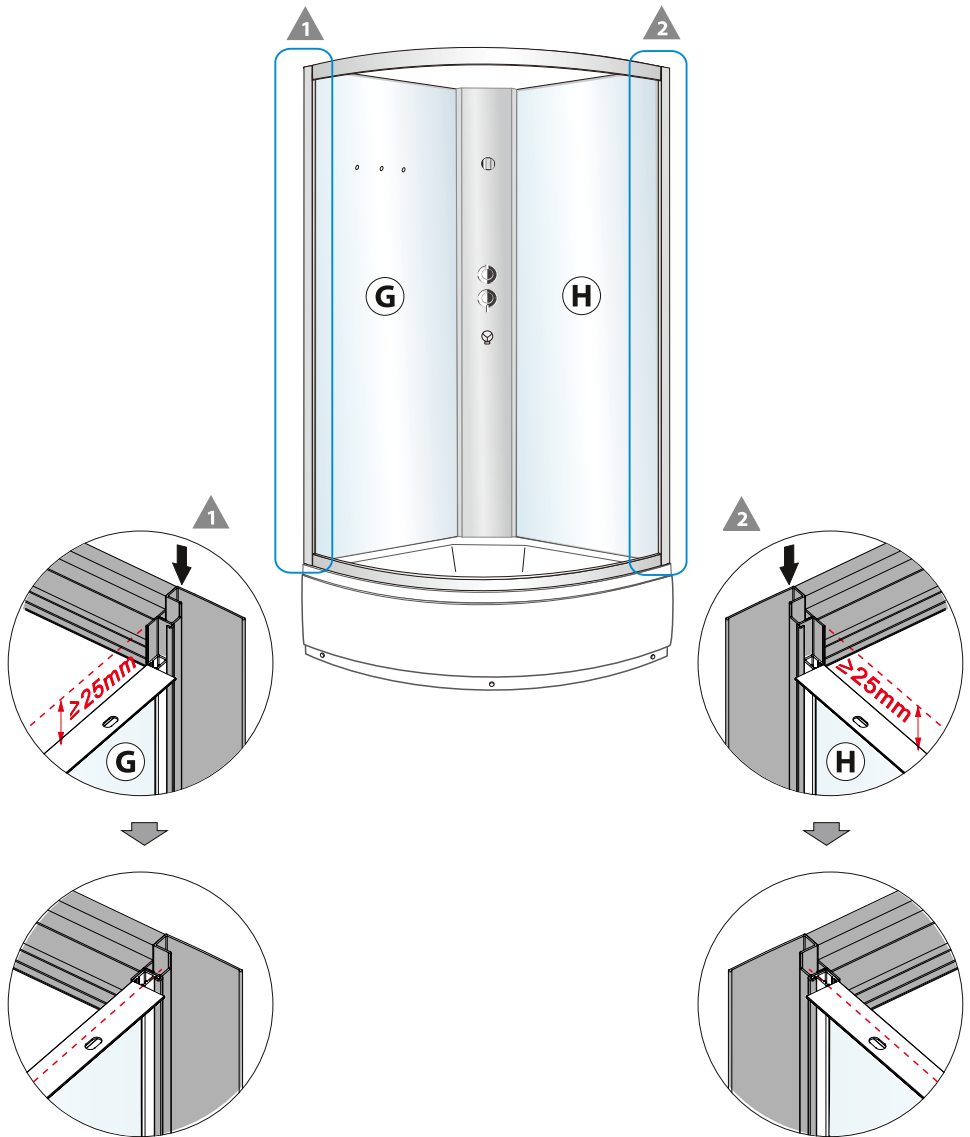

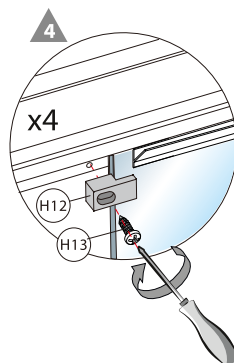
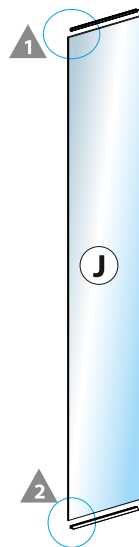
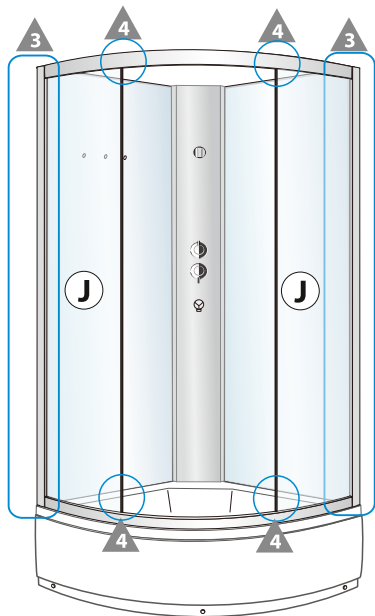
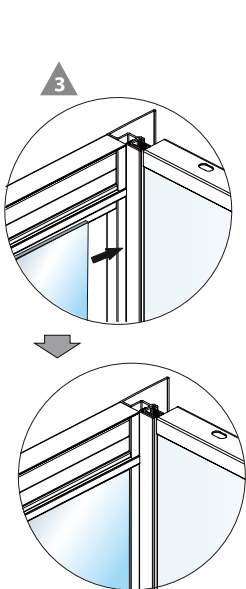
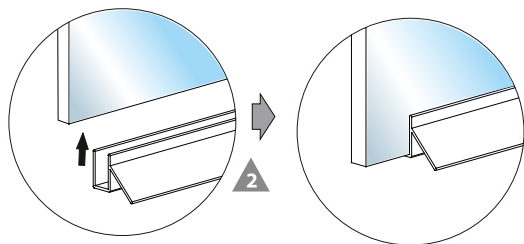
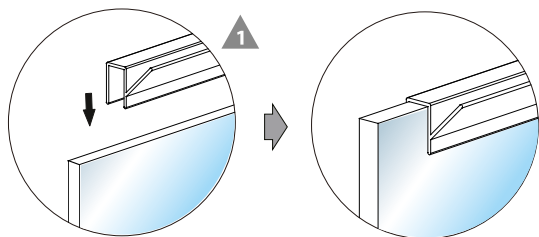

J



x2

H14



x4

H12



x4

H13



St4X12

x4

2

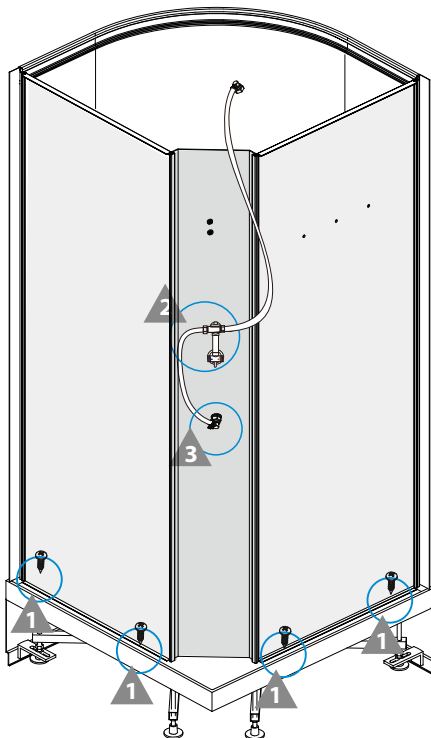
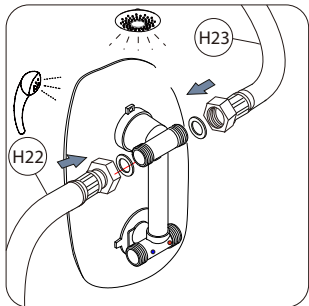

3

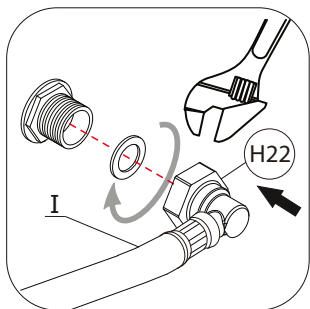

1

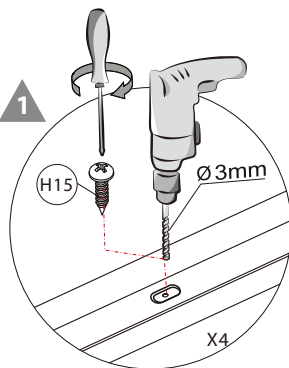

Ø3mm

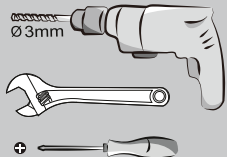

(H15)



St4x12

x4

(H22)



x1

(H23)



x1

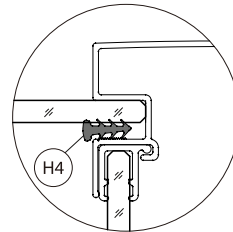
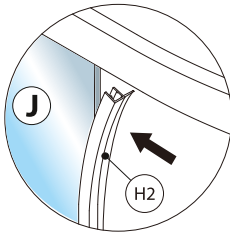
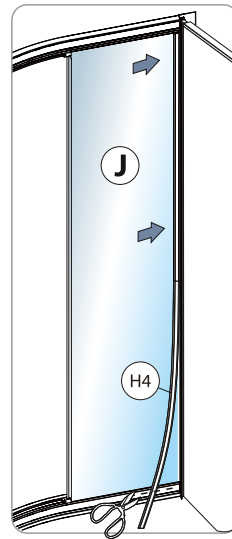
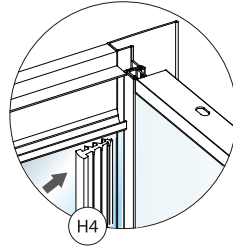
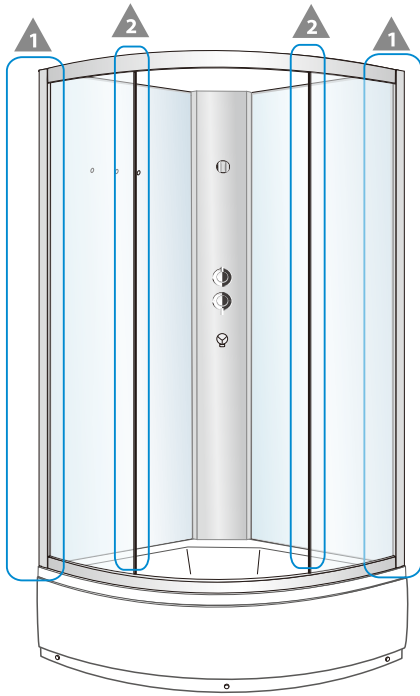

H4



X2

H2

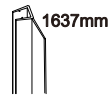

X2

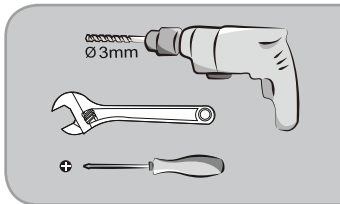
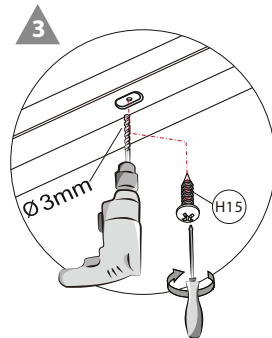
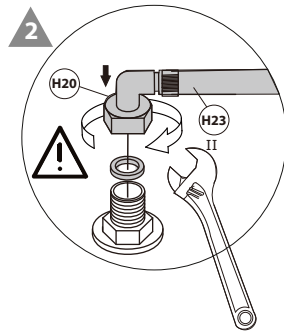
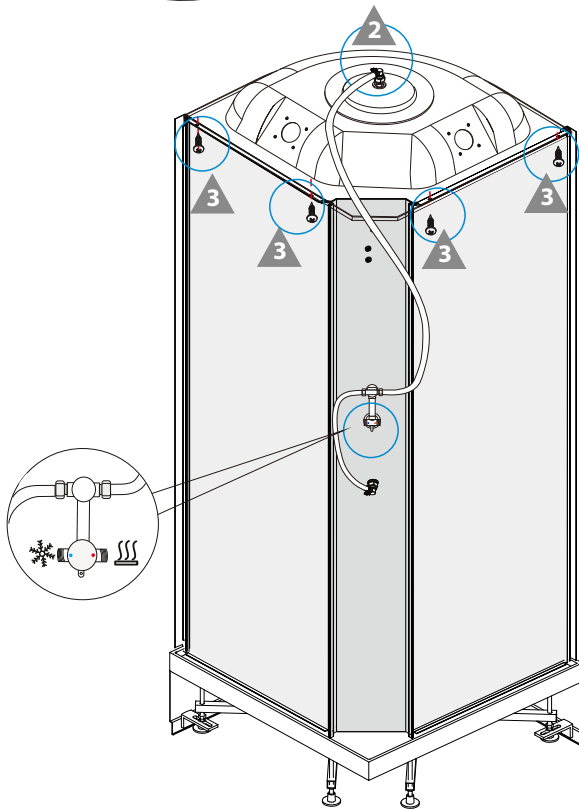
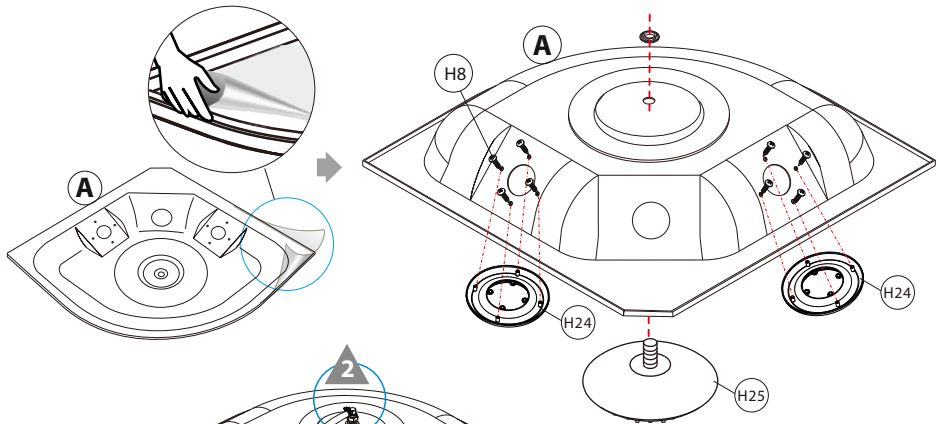

- | A | H8 | H24 | H25 | H15 |
|----|--------------|-----|-----|-----|
| | | | | |
| x1 | St4x10
X8 | x2 | x1 | X4 |

