

VOLUMEN (l)
VOLUMEN (l)





MAX. OBREMNITEV (Kg)
MAX. OBTEREČENJE (Kg)



OBREMNITEV TAL (Kg/m²)
OBTEREČENJE PODA (Kg/m²)



650



990

340

-  - Prostor za el.vodnik 3x2.5mm²(230V,16A/L,N,≡) L=2,5m
-  - Mjesto za el.vodnik 3x2.5mm²(230V,16A/L,N,≡) L=2,5m
-  - Prostor za dodaten el. vodnik 6mm², za ozemljitev kovinskih delov; L=2.5m
-  - Mjesto za dodatni el. vodnik 6mm², za ozemljenje metalnih djelova; L=2.5m

-  - Priklop tople in hladne vode 1/2" min 0,2MPa, max 0,4MPa
-  - Priključak tople i hladne vode 1/2" min 0,2MPa, max 0,4MPa

-  - Prostor za odtok Ø 50 mm
-  - Mjesto za odtok Ø 50 mm

-  - Opcija-obloga
-  - Opcija-obloga

PREDLOG VGRADNJE
PRIJEDLOG UGRADNJE

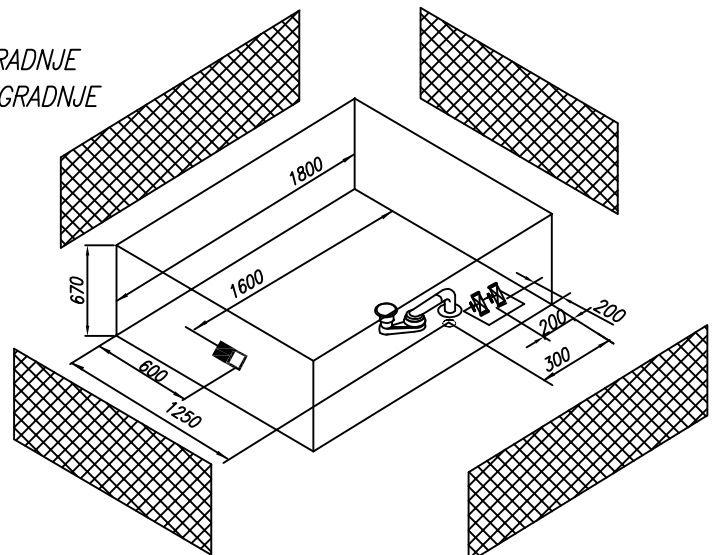

Priporočena prelivna garnitura Preporuka prelivne garniture	PAL 650
Priporočila za vgradnjo kadi brez obloge Preporuka za ugradnjo kade bez obloge	Nr. MK 03
Priporočila za montažo kadi z oblogo Preporuka za ugradnjo kade sa oblogom	Nr. MK 01
Opcija podnožja kadi za vgradnjo Varianta postolja za kade bez obloge	Nr. MK 10 PKK 800 -2x
Opcija podnožja kadi z oblogo Varianta postolja za kade sa oblogom	sestavljeno sastavljeno